



INFORMATION

2015 Vol.20 **E**

ISO 9001

since1922

Grinding expertise for



I am Masuko's
90th anniversary mascot

「**Max**」

My best greetings.

Height 150cm.

Please come to see me!

worldwide demand.

Contributing to industries world wide with advanced grinding expertise.

The recent rapid progress of advanced technologies and constant pursuit of high quality are demanding higher technical levels in every industry. Particularly powder processing industry is confronting a challenge of achieving such a finer product as nanometer particle size, under a recent circumstances that focus on technologies enabling further ultra-fine pulverization.

In 1965, Masuko became the first manufacturer in the world to commercialize an innovative friction grinder using a grinding wheel. It was called "Supermasscolloider". Since then, Masuko has introduced a broad range of machines that achieve ultra-fine pulverization for an expanding range of materials. Masuko's superb expertise and technologies offer unlimited possibilities for tackling such challenges as recycling and saving resources, anti-pollution control, developing new materials to achieve greater economic effects and global environmental conservation. Masuko will further research and develop triturating technologies, and are willing to confront a challenge of achieving technologies enabling ultra-fine trituration of all materials except for diamond.

With the approach of the twenty-first century, Masuko obtained ISO9001 & 14001 qualifications in order to buildup their management foundation. For future they will give first priority to "Customers' Satisfaction" and "Improvement of Management Quality", and carry out earnestly the TQM "Ambition-Action 21".

We sincerely ask for your favorable consideration and valuable support to our future activities.



Restored model of 18 lb. cannon
(near the front gate).

The original - allegedly unproducibile at that time - was produced by the 3rd of the Masuda family (CEO of Masuko Sangyo) in 1852.

MASUKO-pursuing customers' satisfaction

Outline of the Company



Name	Masuko Sangyo Co., Ltd.
Address	12-24 Honcho 1-chome, Kawaguchi-city, Saitama 332-0012, Japan Tel.+81-48-222-4343
Predecessor established:	April 1922
Masuko established:	August 1971
Capital	10 million yen
Fiscal Year-end	End of June (annually)
No. of employees	25
Executive officers	President:Sachiya Masuda
Main banks	Kawaguchi Shinkin Bank, Head office Musashino Bank Kawaguchi branch
Operations:	Manufacturing and distribution of: Ultra-fine friction grinder Supermasscolloider, Supermasscolloider α , etc. Ultra-precise cutting machine Micro-Meister Air-flow type ultra-fine micronizer Ceren Miller, Ceren Miller DAU, Ultra-high-pressure wet jet mill Masscomizer X Other micronizer Atomizers, Cutter Mill, Shredder, Bone Cutters, Choppers, etc. Peripheral equipment Conveyors, Pumps, Mixers, Chargers, Weighing machines, etc.
Overseas agent	Korea • China • Taiwan • Thailand • Singapore • Malaysia • Indonesia • Philippines • India • EU

Organization

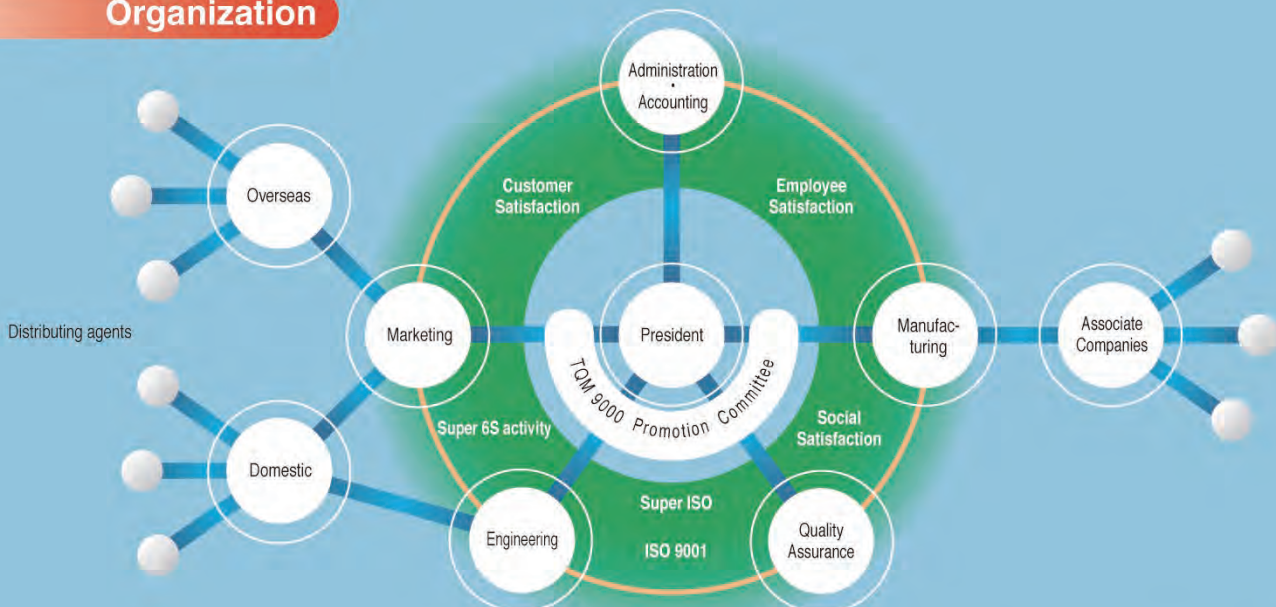

● In communication type of organization with an emphasis on horizontal connections, We will "pursue happiness" through the Super 6S activities

and management quality improvement.



93th Anniversary. Thank you.

Milestone

- | | |
|--|--|
| <p>Around 1750 Manufactured hundreds of cannons under the leadership of Shuhan Takashima in the last days of the Tokugawa Government, then businesses were developed into the form of present industrial enterprise.</p> <p>April 1922 Started sales of special products of Kawaguchi at Honcho 4-home, Kawaguchi-city</p> <p>August 1947 Started production of castings and other industrial machines at Honcho I-chome, Kawaguchi-city</p> <p>1965 Developed the Supermasscolloider.</p> <p>August 1971 Reorganized into Masuko Sangyo, Co., Ltd.</p> <p>1972 - 1979 Developed a fully automatic tofu (bea curd) manufacturing plant; developed chicken and pig bone marrow remulsion manufacturing lines; and started sales of small-scale <i>tofu</i> manufacturing units in the U.S.</p> <p>October 1982 Developed cattle bone marrow remulsion manufacturing lines.</p> <p>September 1984 Developed manufacturing lines for composite fuel containing carbide colloidal.</p> <p>November 1985 Awarded the Saitama Industrial Technology Grand Prix for the polymer complex structure of a grinder and its manufacturing method.</p> <p>January 1986 Awarded a prize in recognition of technical services to the food industry for the development and the distribution of the "Supermasscolloider," a grinder producing ultra-fine particles.</p> <p>February 1986 Awarded a prize for inventing a system that converts bones into a food material</p> <p>February 1987 Awarded a prize in recognition of the innovative idea of polymer complex structure for grinding-head.</p> <p>April 1988 Awarded a prize by the director general of the Science and Technology Agency for developing ultra-fine grinders.</p> <p>August 1988 Developed "Grindell" grinders which were patented in the U.S.A. and the U.K.</p> <p>May 1989 Awarded a prize from the Japanese Society for Food Science and Technology for developing a triturator and applying it to the food industry.</p> | <p>May 1989 Tsuneo Masuda, chairman, was awarded the Yellow Ribbon Medal. by Japanese Government</p> <p>October 1993 Developed "Cerendipitor" to enable ultra-fine grinding of difficult-to-crush materials.</p> <p>October 1993 Awarded a prize for the inventing the Cerendipitor high-speed grinder.</p> <p>November 1994 Hatogaya Plant No.2 completed.</p> <p>December 1994 Company-wide Five "S" campaign launched.</p> <p>September 1995 New head office plant completed.</p> <p>May 1996 TQM "Ambition - Action 2000" campaign initiated company-wide.</p> <p>April 1998 The patent for anti-bacterial type grinder was granted.</p> <p>October 1999 Developed a air-flow type ultra-fine micronizer "Ceren Miiller".</p> <p>February 2000 Acquired ISO9001 qualification.</p> <p>February 2001 Acquired ISO14001 qualification.</p> <p>January 2002 Started company-wide activity pursuing customers' satisfaction and management quality improvement.</p> <p>June 2002 Developed Ultra-precise cutting machine "Micro-Meister".</p> <p>June 2006 Developed Media-less hyper fine micronizer "Masscomizer X"</p> <p>December 2008 Joined Super ISO research group.</p> <p>June 2009 Developed multi functional grinding machine "Supermasscolloider-α"</p> <p>July 2009 "New 6S Activity" initiated company wide.</p> <p>June 2011 Developed Under decompression air-flow type ultra-fine micronizer "Ceren Müller DAU".</p> <p>June 2012 All employees went to the Great East Japan Earthquake volunteer.</p> <p>2013 Exported Supermasscolloider to 22 countries for cellulose nano fiber application.</p> <p>July 2013 "Super 6S activity" initiated company wide.</p> <p>October 2014 Manufacturing subsidy recognition</p> <p>January 2015 Developed forth generation "New Supermasscolloider"</p> |
|--|--|



I am Masuko's
90th anniversary mascot
「Max」
My best greetings.
Height 150cm.

We have various challenges!

Putting our hearts into every process,

Pursuit of happiness through the Super 6S activities

Since 1994, we continued 5S, ISO, TQM, 6S, Super-ISO activities.

As we celebrate the 2014 milestone of 20 years, we change appellation as “Super 6S activity”. With new original key words such as “**Creation, Evolution, Success, Growth, Deep Performance, Happiness**”, we restart activity toward the culmination.



People work for what?... Let's create happiness through the work!

“Participating in the **creation** of new value with fellow, **evolving** the company, increasing the **successful** experience, **growing** their own, do **deep performance**, and making people **happy** to be associated with this project = Masuko Sango” is new management philosophy. We aim to the company that has “Ability to think deeply things”, “Problem-solving ability”, and “To share the human resources and organization that can adapt to environmental change”.

As there is a quality in thing, there is a quality to people. Human quality. To raise the human quality, the system quality and the product quality. It will lead to raising the overall quality of the company as a result. We want to be the company that delights customers, admitted serving, the employees work with a smile.



Technical Department (3D CAD)



Head Office Plant

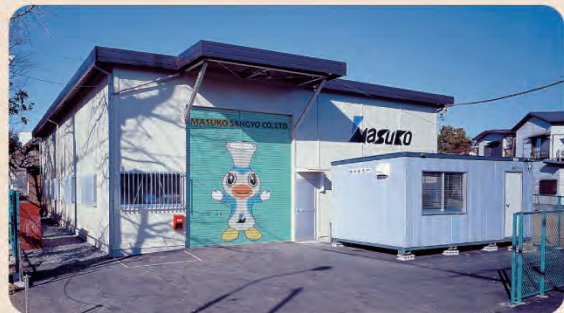

Plant No.2



Quality inspection



ISO9001



CE marking self-declaration.



KCS authentication certificate

this is our mission.



Marketing Department

Head Office Plant



Grinding all kind of substances except

■ Super ISO activity

The demanded thing to Masuko Sangyo now is “mind”. That is a key word. We have “5S activity” and “quality system” that we can proud of. Putting mind in the system is needed.

ISO9001 is the system to guarantee quality without mind. It is obvious that if we put mind in it, it will be much better system. Not only following the rules, but also to think what to do to better is necessary. Making improvements to bring awareness of the issues is needed to cultivate.

Masuko Sangyo has started participating Super ISO research group that is organized by Japanese Industrial Standard since 2009. Bases are manipulating ISO 9001, realization of competition supremacy, and scientific problem solving methods. Built-in TQM thinking, goal type activity. To base up an activity to TQM9001 are our effort. We believe that with this activity, competitive products, continuous serving company with a dream is possible.

■ Grinding all kind of substances except diamond to super fine particle.

The recent rapid progress of advanced technologies and constant pursuit of high quality are demanding higher technical levels in every industry. Particularly powder processing industry is confronting a challenge of achieving such a finer product as nanometer particle size, under a recent circumstances that focus on technologies enabling further ultra fine pulverization.

To make nano size particle is an important theme for realization of a recycling-oriented society, resource saving, low pollution, and developing new materials. Masuko Sangyo will pursue further grinding expertise in both wet and dry applications to develop our technology.



New material/product display room



Test room No.1



Analyzing room

diamond to super fine particle.



Nano Laboratory



Meeting

Test room No.2



SUPERMASSCOLLOIDER® (Ultra-fine friction grinding machine)

Masuko's Supermasscolloider, which is even called "Dissolving Machine", can make ultra-fine particle products which looks as if dissolving. The Supermasscolloider, ultra-fine grinding machine features two ceramic non-porous grinding stones. Clearance between these two stones can be adjusted freely. While the upper grinding stone is fixed, the lower one is rotated at a high speed. Raw materials fed into the hopper are dispersed by centrifugal force into the clearance between those grinding stones, where they are ground into ultra-fine particles, after subjected to massive compression, shearing, and rolling friction forces. As is a stone-mill type machine, it produces more round shape and smoother particles than other type of crushing machines. The product consists of uniform size of particles.



● Setting the clearance between two grinding stones is an important work, since it secures high quality of the product. When turning the adjusting handle, the clearance increases or decreases by a unit of 1/100mm. Besides, during "0" operation (two grinding stones contact each other), the clearance can be adjusted freely.

MKCA6-2J Wet Dry

● Compact type for laboratories and small volume production. These machines can grind small lot of materials with 100% recovery. They are extremely easy to disassemble, clean, and reassemble.

Specifications

Model	MKCA6-2J	MKZA6-5J
Motor	1.5Kw, 3P	3.7Kw, 3P
Grinder diameter(mm)	φ150	φ150
Standard capacity (Kg/Hr)	(wet)	30~100
	(dry)	1~10
External dimensions W×L×H(mm)	350×650	560×1097×1055~1632(MAX)
Weight	60Kg	230Kg

※Movable up and down width 577mm



▲MKCA6-2J



▲MKZA6-5J

MKZA10-5LDR Dry

● Models for dry materials only, grinding to 1-30microns. These machines can efficiently pulverize small amounts of materials that are fibrous and vulnerable to heat, such as powder tea and chitosan. Rotary speed can be adjusted within the range from 0 to 830rpm.

Specifications

Model	MKZA6-2LDR	MKZA10-5LDR
Motor	1.5Kw, 3P	3.7Kw, 3P
	Variable speed	Variable speed
Grinder diameter	φ150mm	φ250mm
Standard capacity(dry)	0.1~3Kg/Hr	0.3~5Kg/Hr
External dimensions W×L×H	500×550×1200mm	600×600×1200mm
Weight	150Kg	250Kg



▲MKZA10-5LDR

MKZA10-15J IV Wet Dry

●The birth of Supermasscolloider to has elapsed 50 years. Forth generation, New Supermasscolloider (MKZA10 series) has been developed to its turning point. It complies safety of global standards such as CE marking, KCS mark, and UL. It is a new type friction grinding machine in pursuit of ease of use and functionality. Even part time staff can use the machine easily. Moreover, we provide three types of bearing mechanism that corresponds to tough environment such as high temperature, high pressure, and 24 hours operation.

Specifications

Model	MKZA8-10J IV	MKZA10-15J IV	MKZA12-20J IV
Motor	7.5~15Kw, 3P		
Grinder diameter	φ200mm	φ250mm	φ300mm
Standard capacity(wet)	30~500Kg/Hr	70~1000Kg/Hr	120~1700Kg/Hr
External dimensions W×L×H	685×1050×1370mm		
Weight	220Kg	250Kg	300Kg



MKZA15-40J Wet Dry

●A medium-sized grinder for low to moderate viscosity materials. With a capacity of 300-3,000kg/hr., this medium-sized grinder with jacket, is widely available for mass-production applications. The spring-damper assists lid to open and close easily.

Specifications

Motor	15Kw~30Kw, 3P
Grinder diameter	φ360mm
Standard capacity(dry)	300~3000Kg/Hr
External dimensions W×L×H	750×850×1685mm
Weight	650Kg



MKZB20-100J Wet Dry

●Large grinders for highly viscous materials. These models are among the world's largest machines.

Specifications

Model	MKZB15-50J	MKZB20-100J
Motor	30~55Kw, 3P	37~160Kw, 3P
Grinder diameter	φ360mm	φ500mm
Standard capacity(wet)	0.3~3TON/Hr	1~5TON/Hr
External dimensions W×L×H	780×2100×1530mm	900×2500×1800mm
Weight	1300Kg	2500Kg



SUPERMASSCOLLOIDER α [®] (Multi functional mill)

Supermasscolloider α is the compact and high performance multi mill that has 14 functions by changing core parts.

Multi function system like the food processor is applied to this triturating machine, and it can be used for both wet and dry trituration methods. Rough cutting, ultra fine cutting, slicing, and dicing are possible for many uses.



● Convenient for R&D research use and Hotel & Restaurant kitchen use. Existing customers can also use α parts to their machines. For more information, please contact Masuko Sangyo.

α 10 series with Micro cutter(M)

MKCA6-2J α

α 6 series

14 kinds of different functions

● It is easy to operate because of its compact size. One machine for 14 functions by changing core parts inside braking chamber. Most suitable type for laboratory and small production.

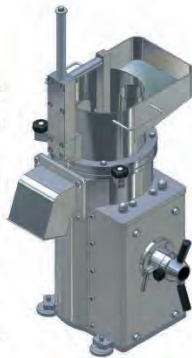

Specifications	
Motor	1.5Kw, 3P
Standard Capacity	30~100Kg/Hr
External dimensions WxLxH	445 x 445 x 715mm
Weight	60Kg

MKZA10-20J α

α 10 series

13 kinds of different functions

● Most popular medium sized production machine. 100% corresponding to customer's needs by one machine.

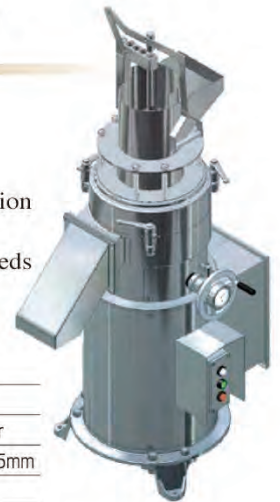

Specifications	
Motor	15Kw, 3P
Standard Capacity	70~1000Kg/Hr
External dimensions WxLxH	860 x 860 x 1375mm
Weight	250Kg

MKZA15-40J α

α 15 series

3 kinds of different functions

● Large type of α series. Mass production machine with jacket structure for many applications. Easy to handle by upper lid spring system. Whole cabbage can be fed into the hopper.



Specifications	
Motor	15~30Kw, 3P
Standard Capacity	300~3000Kg/Hr
External dimensions WxLxH	1320 x 1320 x 1765mm
Weight	650Kg

W Core system

Applying patent now



Chop cutter(CO) with Grinder(G)

W core system unites plural different core parts in one main body, and smooth process is possible by excellent system. It is the most appropriate system for saving space and cost.

α Core parts

W = Wet D = Dry



Grinder (G) W D

Friction grinding by one pair of non-porous grinders. Raw materials fed into the hopper are dispersed by centrifugal force into the clearance between those grinding stones where they are ground into ultra fine particles, after subjected to massive compression, shearing and rolling friction forces. Masuko Sangyo has 150 kinds of grinders.

corresponding machine α6 • α10 • α15

Grind



Hammer (H) D

Attached hammers on the rotary disk rotate inside lining. Raw materials become fine powder by impact, friction, compression, and collision of materials. Hammering function has big capacity and stable product particle size.

corresponding machine α6 • α10

Hit



Chop cutter (CO) W D

Materials are cut on horizontal cutter and vertical cutter into fine pieces. Making paste of materials that have strong fiber such as ginger is possible without preparation. 2 step cutters, 3 step cutters, 4 step cutters are possible to set up.

corresponding machine α6 • α10

Chop

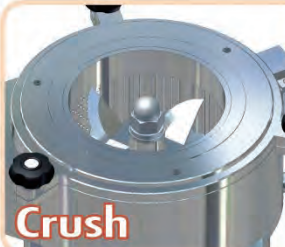

Crush cutter (CR) W D

Powdering of high oil content materials that are weak to heat such as peanut and sesame seed. Materials with strong fiber can be cut sharply. All periphery screen type is available.

corresponding machine α6 • α10 • α15

Crush



Grater (GT) W

Materials are grated by projecting on the rotary plate. Special disk for finer grate is available. Fruit size like an apple can be fed without precutting.

corresponding machine α6 • α10

Grate



Slice cutter (S) Dice cutter (D) W

Materials are sliced by rotary round slicer and cut by dicer where right under slicer. Materials become dice. By taking off dicer, sliced products are obtained. Fruit size like an apple can be fed without precutting.

corresponding machine α6 • α10

Slice, Dice



Cutter mill (CM) D

Applicable various uses for both hard and soft materials. Material fed into hopper is cut by the edge of three steps rotor and fixed three pieces knives on the outskirts part. Only products that are smaller than hole size of the Screen are discharged.

corresponding machine α6 • α10

Crush cut



Juicer mixer (J) W D

For making fresh juice with rich food fiber or crushed ice juice. High working efficiency by using strong large scale cutter. Necessities for making a fixed quantity of vegetable or fruit juice with seasoning.

corresponding machine α6

Blend



Grain (GR) D

Star shaped special knife is suitable for crushing and granulating of raw material. It is possible to suppress the pulverization of the fine powder. It is good for material with strong fiber and adherent material.

corresponding machine α6 • α10

Ravel



Dehydrator (DR)

Solid-liquid separator which is available in a range of 1,000 to 3,000rpm as a simple centrifugal dehydrator. It is also good for dehydrating slurry of 20um material.

corresponding machine α6

Squeeze

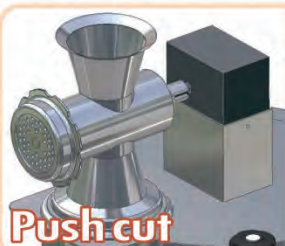

Chopper (CH) W

Stainless steel mincing machine. Meat, fish, of course, vegetables and fruits also briefly minced. **World first grinder** that can make sesame paste and Surigoma.

corresponding machine α6

Push-cut



Cutter mixer (CX) W D

The high-speed rotation and the cutter knife, it is a mixer to cut and mixed and emulsified any material instantly. Freely adjustable the rotation speed by inverter, enables processing on the fine adjustment, widely available from food to industrial raw materials.

corresponding machine α6

Cut mix



Micro cutter (M) W

Ultra precise cutting of micron size level is achieved by the shearing force generated between a speedily spinning rotor and many blade edges which are planted in a ring placed around the rotor. Cutting heads of Micro-Meister (3M series) can be attachable.

corresponding machine α10

Micro cut



Rough cutter (R) W D

Material is pressed against the inner surface of the basket cutting head by centrifugal force which is generated by a speedily spinning rotor, and it is cut by the knife inside basket cutting head. Basket cutting head of Micro-Meister (4M series) can be attachable.

corresponding machine α10

Rough cut

SMART MEISTER® FUNCTION (Computer aided automatic ultra-fine grinder)

Conventionally, subtle clearance adjustment had done by veteran workers, we will do on behalf of the electronic eyes of smart Meister function.

Smart sensor constantly monitors the operation state, to keep the product particle size and temperature constant. You can set a 24 kinds of operation pattern, one button in it is varieties instead, it does not involve troublesome setting work.

It also makes possible to control plural Supermasscolloids from one screen, and it is more convenient to use.



A display example

MKCA6-5JM Wet Dry

● Small grinder with Meister function was born. It is good for research site that reproducibility is important and high-mix low-volume production. Movement of the machine location is easy.

Specifications	
Motor	3.7Kw, 3P
Grinder diameter	φ150mm
Standard capacity (wet)	30~100Kg/Hr
External dimensions W×L×H	560×1097×1055~1632 (MAX)mm
Weight	235Kg

※Movable up and down width 577mm



MKZA10-20JM IV Wet Dry

● In addition to the safety of the world standards such as CE marking, it is the most popular small production machine that has ease of use and functionality. Even part time staff can use the machine easily and get uniform product by switch Pong!

Specifications	
Motor	15Kw, 3P
Grinder diameter	φ250mm
Standard capacity (wet)	70~1000Kg/Hr
External dimensions W×L×H	685×1050×1370mm
Weight	280Kg



With caster type

MKZB15-50JM Wet Dry

● By introduction of Meister function, no longer need a skilled worker. Checking clearance under unattended operation in inline. Allowing uniformed grinding and stable production.

Specifications	
Motor	37Kw, 3P
Grinder diameter	φ360mm
Standard capacity (wet)	300~3000Kg/Hr
External dimensions W×L×H	780×2100×1340mm
Weight	1300Kg



GRINDERS

Our ultra-fine friction grinding machine is equipped with special grinders, which produce overwhelmingly fine and round-shape particles of products. These grinders have 200 kinds and over variations classified in material itself, material particle size, or ditch style. Besides, anti-bacterial grinders are added in our range which keep good sanitary conditions at foodstuff industry that corresponds to HACCP.

NONPOROUS GRINDER

As previously mentioned briefly, conventional grinders have a porosity of about 40%. Accordingly, when raw food materials such as animal bones are triturated, the liquid containing nutrients such as protein enters the inner part of the grinder which promotes the growth of innumerable bacteria. Also sometimes these pores cause cracks of grinder due to uneven heat distribution or thermal stress. The Supermasscolloider solves these problems completely, there is no growth of bacteria and no crack due to thermal stress. It contributes the improvement of yield and overwhelmingly fine particles.

Patented anti-bacterial Masscolloider

Nonporous,
No water permeation

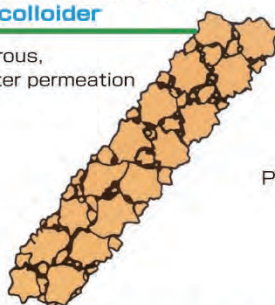

Conventional grinder

Porous. When water is poured, it permeates immediately in pores.

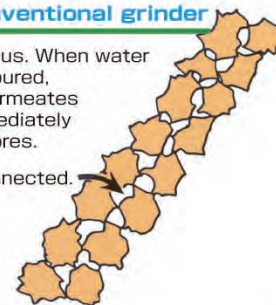

Pores connected.

※ Anti-bacterial grinders are Masuko's patented products.

W = Wet D = Dry



16#, 24# (coarse) 46# (fine)

SiC + Al₂O₃
For soft material standard grindstone

※ Antibacterial version available
For making pastes of vegetables, fruits, meat, sesame seeds, peanuts, pigments, plaster, sea weeds, soy beans, rice, Japanese horseradish, ginger, etc.



(Special fine grinding)

Si₃N₄ & ZrO₂
For extra-hard material

For powdering or slurring glass, minerals, medical materials, plaster, pigments, antimony trisulfide, ink lead, calcium hydroxide



24#, 46# (fine) 80#, 120# (Ultra-fine)

Al₂O₃ <MK G-A>
SiC <MK G-C>
For pulverizing and emulsifying fibrous material

※ Antibacterial version available
For pulverizing corns, ginger, mustards, almonds, carbon, talc, silica, cellulose, etc., and for emulsifying grease, cosmetics, etc.



(Special intermediate grinding)

Al₂O₃
For white material

For powdering or slurring white materials, including cosmetics, pigments and drinks.



40#, 60# (fine)

C100% [diamond]
For hard materials

For powdering or slurring egg shells, minerals, bones, metal oxide, fossil shells, zeolite, polyimide fluororesin, etc.

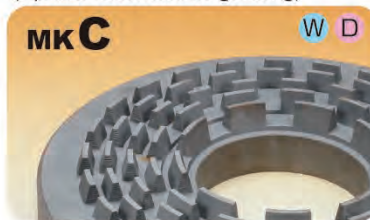

FcD60 & SUS
For preliminary grinding/kneading powdery materials

For preliminary grinding of bones, wood chip, resin pellet, etc., or for mixing / knead-ing pigments, etc.



(Intermediate grinding)

SUS304/316
For special materials

For powdering or slurring medical materials, etc.

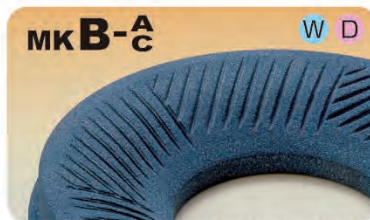

16#, 24# (coarse) 46#, 80# (fine) 120#, 220# (ultra-fine)

Al₂O₃ <MK B-A>
SiC <MK B-C>

For powdering mugworts, herbs, spices, minerals, powder tea leaves, chitosan, potassium sulfate, chlorella, nitric acid, etc.



SiC composite
For hard material, wear resistant grinder

For pigments, dyes, lubricants, cosmetic ingredients, ointments, etc.



correspond to MK E, MK New E, MK G, MK B
For emulsification promoting dispersion

MICRO-MEISTER® (Ultra-precise Cutting)

"Micro-Meister" is a ultra-precise cutting machine with the ultra-high speed which has never been achieved. Ultra-precise cutting of micron size level is achieved by the shearing force generated between a speedily spinning rotor and many blade edges which are planted in a ring placed around the rotor. Micro-Meister, the first multi-functional triturating machine in the world can operate with three triturating tools, i.e. Cutting Head, Basket Cutting Head, and Grinder which work out in different effects. Micro-Meister can be applied in various industrial fields like foodstuffs, spices, pharmaceuticals, chemicals, cosmetics, etc. Its driven part is supported by oil mist lubricating system, and can rotate with high speed continuously, as well as evolves less heat when operating.

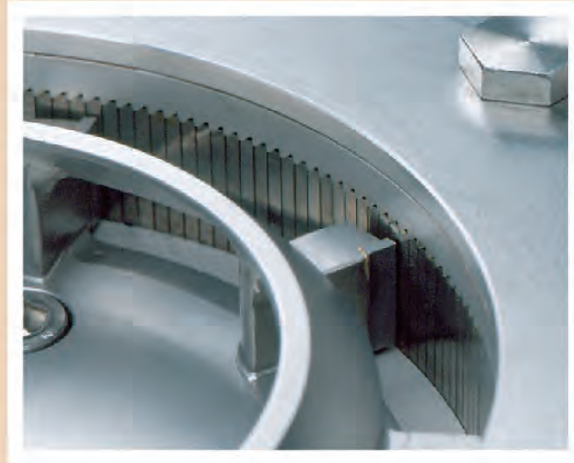

3M7-40 Wet Dry

●The rotor and the blades are very precisely machined so that the clearance between them keeps 300um. Number of blades ranges between 50 and 222; over 10 kinds of cutting heads are available which provide rough cutting, minute cutting, and ultra-minute cutting. If preferable, basket cutting head or grinder can be equipped.

Specifications	
Motor	30Kw, 3phase
Rotating speed	6,000~12,000r.p.m.
Standard capacity(wet)	1,500~3,000Kg/Hr
External dimensions WxLxH	540x1135x1402mm
Weight	500Kg(main body)

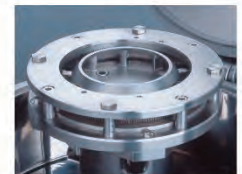

Cutting Head



Grinder

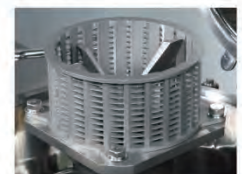

Basket Cutting Head

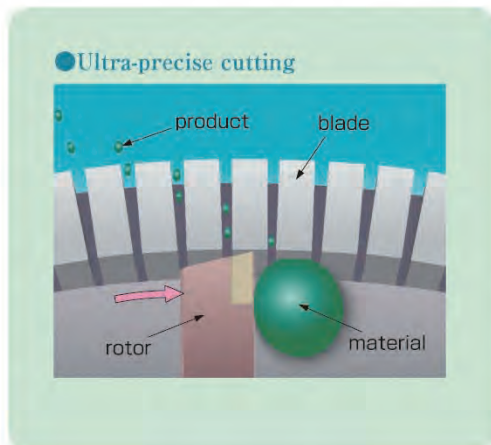

●Consistent size of product

Two kinds of blades are available; one is "S" type for ultra precise cutting, the other is "L" type for normal precise cutting. There are two kinds of blades such as super hard and ceramic made.

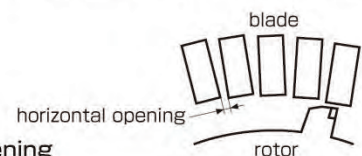

Number of blades and horizontal opening

No. of blades	"L" type blade					"S" type blade								
	50	70	80	90	100	140	160	180	190	200	212	216	220	222
Size (mm)	5.6	2.9	2.0	1.4	0.8	1.3	0.9	0.5	0.4	0.3	0.1	0.08	0.05	0.02

MICRO-MEISTER MINI[®] (Precise Cutting)

As Micro-Meister, Mini is a wet and dry tritulating machine which has a plentiful lineup of basket cutting heads, it can provide various product sizes to meet your requirement. Material is pressed against the inner surface of the basket cutting head by centrifugal force which is generated by a speedily spinning rotor, and it is cut by the knife inside basket cutting head. The product size is quite consistent. This machine is highly applicable to poultry and fish meat processing, and to vegetable and fruit processing.

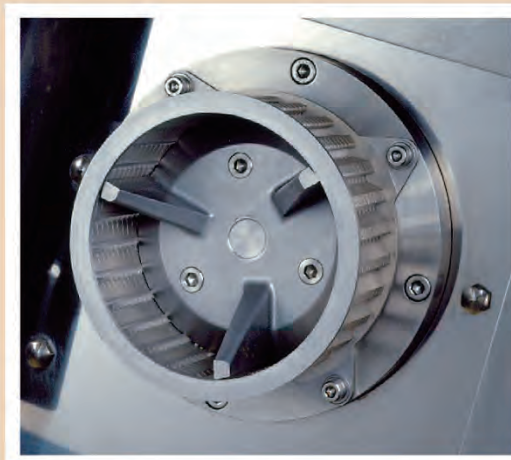

4M7-10 Wet Dry

● Basket Cutting Head which is mounted on this machine varies in the size of its horizontal opening. Its lineup is plentiful between 0.25mm - 12.90mm. As the structure is simple, it is easy to disassemble and clean.



Specifications	
Motor	7.5Kw, 3P
Rotating Speed	1,000~3,600r.p.m.
Standard Capacity	300~1,500Kg/Hr
External dimensions WXLXH	1400×600×1300mm
Weight	120Kg(main body)

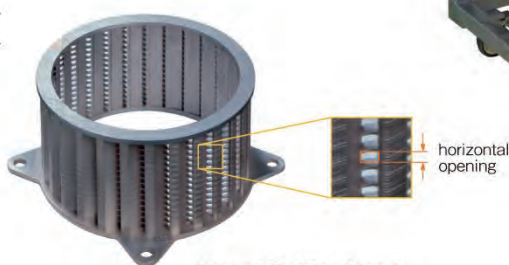

Basket Cutting Head

Precise cutting

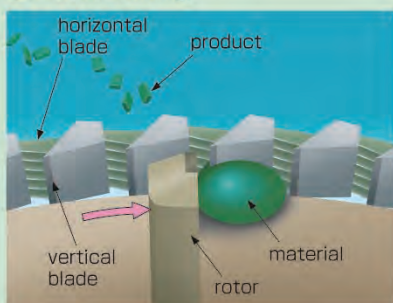

Sizes of horizontal opening

No.	1	2	3	4	5	6	7	8	9	10	11
Size (mm)	0.25	0.38	0.51	0.76	0.88	1.00	1.20	1.50	1.80	2.00	2.20
	12	13	14	15	16	17	18	19	20	21	22
	2.50	3.00	3.81	4.20	5.30	6.00	6.80	7.60	8.40	9.90	12.90

※ Basket cutting head can also be used with 3M7-40 model.

CEREN MILLER® (air-flow type ultra-fine micronizer)

Rapid spinning air-flow caused in triturating chamber by speedily rotating impeller generates impacting, shearing, compressing, triturating and vibrating forces to mill material into ultra-fine particles. Ceren Miller is a hybrid triturating machine based on three triturating principles: jet trituration, impact trituration, and stone mill grinding.

Ceren Miller is not equipped with a screen, which features its solid and almost trouble-free structure. Screening impeller existing in triturating chamber also works as screen to confine material particles within the chamber, and triturate them into ultra-fine particles, which show quite uniform particle size of 5 to 10 micron. Product particle size is adjustable by changing spinning speed, blade clearance, feeding speed, and air-flow volume. Every model is equipped with cooling water jacket.

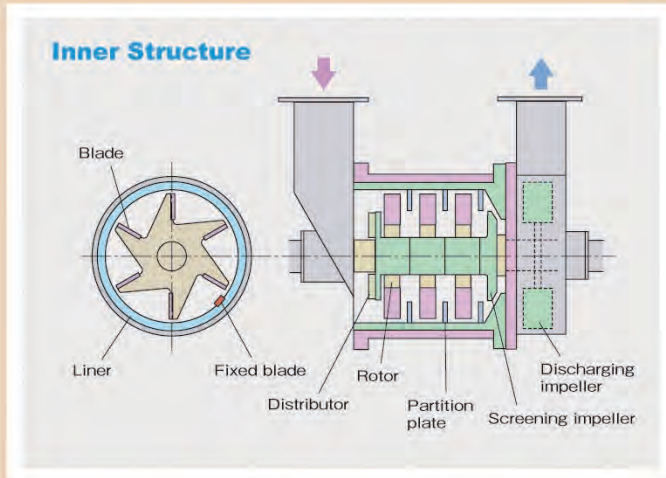

MKCL11-20J Dry

● This model is designed for easy disassembly when cleaning and for easy material change. Though installed in a small area of 1.5m², this model has a large capacity. Its cooling water jacket affords lower temperature of products.

Specifications		
Model	MKCL8-15J	MKCL11-20J
Motor	11~15Kw, 3P	15~20Kw, 3P
Standard capacity	10~50Kg/Hr	30~100Kg/Hr
External dimensions W×L×H(mm)	1000×1400×1800	1000×1500×1400
Weight	280Kg	400Kg



▲MKCL11-20J

MKCL15-30J Dry

● This model is a large triturator for industrial use which afford large capacity and stable production. Main body is made of special solid casting intended for noise reduction. In order to meet application to food stuff or hard material, stainless steel or hardened steel is available as machine structure, which is made-to-order.

Specifications				
Model	MKCL15-30J	MKCL20-60J	MKCL25-100J	MKCL30-200J
Motor	22Kw, 3P	45Kw, 3P	75Kw, 3P	160Kw, 3P
Standard capacity	150~500Kg/Hr	300~900Kg/Hr	450~1500Kg/Hr	600~2500Kg/Hr
External dimensions W×L×H (mm)	1720×1240×870	2000×1450×1030	2450×1750×1200	3140×2000×1380
Weight	2500Kg	3500Kg	5000Kg	7500Kg



▲MKCL15-30J

CEREN MILLER DAU[®] (Under decompression air-flow type ultra-fine micronizer)

Traditional Ceren Miller is a hybrid trituration machine based on five trituration principles: jet trituration, impact trituration, stone mill grinding, compression, and high-frequency vibration to achieve 10 -20 micron size particle. Newly developed Ceren Miller DAU evolved traditional trituration method, and continuous batch method trituration became possible. 5 -10 micron size particle can be achieved, and Ceren Miller DAU can be compared favorably with Jet mill.



MKCL8-15J-DAU Dry

● Not only miniaturize the machine, but also sanitary bag filer is built in. Disassembling, assembling, cleaning of filter are easy. It ensures complete sanitary.

Specifications

Model		MKCL8-15J-DAU	MKCL15-30J-DAU
Motor		11~15Kw, 3P	22~30Kw, 3P
Standard capacity	Continuous batch method	5~15Kg/Hr	15~50Kg/Hr
	Continuous method	10~50Kg/Hr	50~200Kg/H
External dimensions W×L×H		1125×1740×2030mm	We designed for your demand
Weight		1100Kg	4000Kg



▲MKCL15-30J-DAU

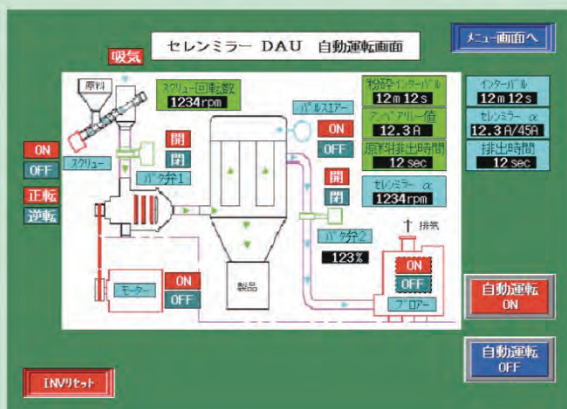

● Continuous batch method trituration under decompression

This is continuous batch method trituration machine under decompression by adjusting material feeding volume.

Characteristic of batch method is “ultra atomization by trituration repeatedly” and “preventing deterioration by decompression trituration” (adiabatic expansion effect works temperature drops). It makes finer particles with less discoloration, less alteration, and less deterioration of taste. Inert gas can be fed under decompression, and it grows material protection effect more effectively.

ATOMIZER (Impact pulverizer: Hammer mill)

Masuko's Atomizer, impact pulverizer are designed to provide high-speed fine crushing at peripheral speeds of more than 100m/sec to make products with uniform grain size at an extremely large capacity. Atomization is attained by swing hammers attached to a rotating disk, which rapidly rotate at a distance of one millimeter inside a fixed lining plate to cause impact, grinding, collapse, and molecular collision. The Atomizer series features rigid casing and case protection parts, enabling durable and problem-free operation.



Option: Rotor for fine grinding



MKA-5J (Dry)

● These are stainless steel, jacket-cooling, small production machines capable of atomizing small amounts of materials. The front cover can be opened for easy disassembly, cleaning and reassembly. The machines enjoy high atomizing efficiency, easily producing fine particles of 200-300 mesh.

Specifications		
Model	MKA-2J	MKA-5J
Motor	0.75~1.5Kw, 3P	2.2~3.7Kw, 3P
No. of hammers	6pieces (1line)	12pieces (1line)
Standard capacity (dry)	10~50Kg/Hr	30~150Kg/Hr
External dimensions W×L×H	720×690×1070mm	940×650×1430mm
Weight	150Kg	250Kg

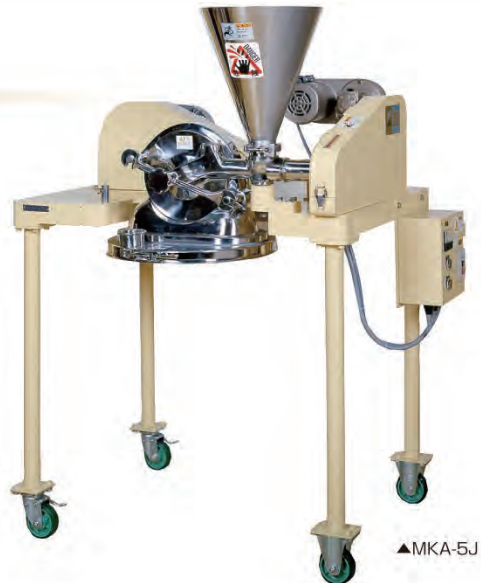

▲MKA-5J

MKA-10J (Dry)

● These large crushers can achieve products of uniform grain size with an extremely large output. Due to the rigid and compact design, they enjoy a wide range of applications in mass-production lines. The hopper can be equipped with a roll or plate permanent magnet or electromagnet to prevent magnetic substances being mixed.

Specifications			
Model	MKA-10J	MKA-15J	MKA-20J
Motor	3.7~7.5Kw, 3P	7.5~15Kw, 3P	11~22Kw, 3P
No. of hammers	12pieces (1line)	12pieces (1line)	24pieces (2 line)
Standard capacity (dry)	50~250Kg/Hr	150~700Kg/Hr	400~1500Kg/Hr
External dimensions W×L×H	1200×1400×1600mm	1500×1300×1800mm	1500×1400×1800mm
Weight	450Kg	800Kg	1000Kg



▲MKA-10J

CUTTER MILL (Pre-crusher)

Masuko's standard Cutter Mill machines are made of stainless steel, making them safe to use for food and medical applications. The edges of knives are cartridges, and it is easy to exchange them. The horizontal structure ensures durable bearings and complete seal for washing. The screens to be fitted below the cutters are available between 1.5 ~ 30mm ϕ .

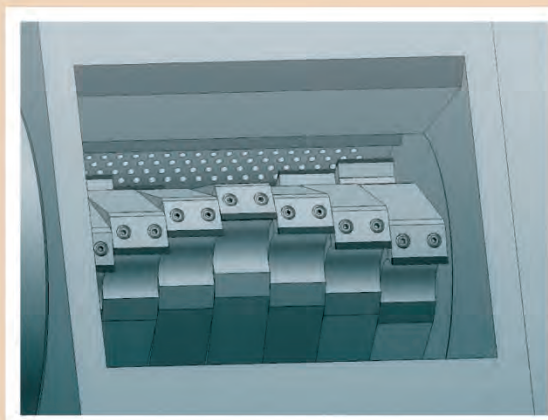

MKCM-5 Wet Dry

● These models enable easy and convenient crushing of various materials, including vegetables, fruits, seaweeds, crude drugs, used paper and fibers, and wood chips. A steel model is also available on request. The screen mounted under the cutter is available in hole sizes between 1.5 ~ 30 mm ϕ .

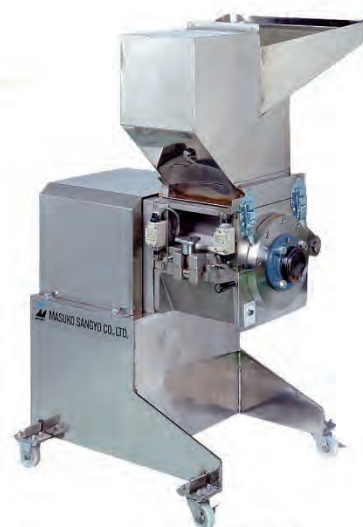

▲MKCM-5

Specifications

Model	MKCM-3	MKCM-5
Motor	2.2Kw, 3P	3.7Kw, 3P
No. of cutters	5 pieces	7 pieces
Standard capacity(dry)	10~50Kg/Hr	30~200Kg/Hr
External dimensions W×L×H	500×600×1000mm	500×750×1000mm
Weight	90Kg	150Kg

MKCM-10 Wet Dry

● Knife material is available both in stainless steel and SK. Screen is easy to clean as well as to change. This machine structure enables easy change of material. A hopper equipped with a magnet is made-to-order to prevent magnetic substances being mixed.



Specifications

Model	MKCM-10
Motor	7.5Kw, 3P
No. of cutters	9 pieces
Standard capacity(dry)	80~500Kg/Hr
External dimensions W×L×H	1000×1000×1500mm
Weight	250Kg

MASSCOMIZER X[®] (Media-less hyper fine micronizer)

Masscomizer X is a device that produces the ultra fine particles which performs emulsification, dispersion, and crushing.

MMX disperse raw material into sub-micron sized fine particles in a short time by passing fluid as ultra high speed with shearing and crushing effects inside the generator that is consisted of stainless steel and diamond. Generated energy is distributed equally, and rather uniform particle size is obtained. Media-less structure makes MMX free from boring media control. By changing the processing pressure and the processing number of time, processing conditions are easily controlled.

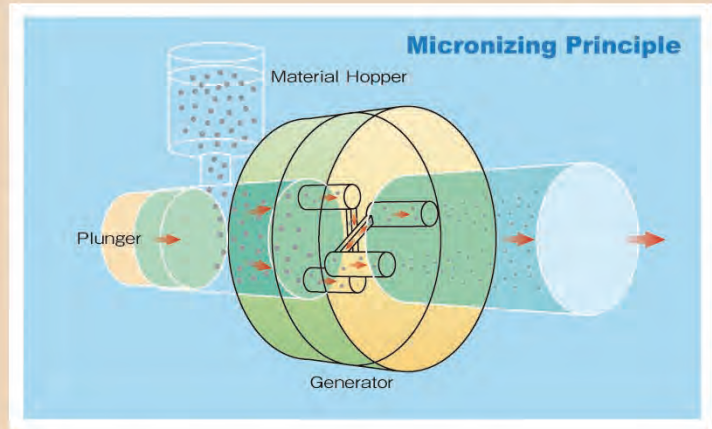

MMX-2000AR air-driven type Wet

● No need of electric power, anti-explosion application. Such a small quantity as 10ml can be processed. Small · light · low noise design. It can be installed anywhere.

Specifications	
Model	MMX-2000AR
Rated processing pressure	200MPa
Max. processed volume (average)	167ml/min
Air supply	640NL/min
Max. input particle size	Max 30μm (less than 10um is recommended)
External dimensions W×L×H	600×300×424mm
Weight	67kg



MMX-200-05DX1 Built-up type for industrial use Wet

● By combined operation, it matches flexibly to various materials and various applications, and also to small production and huge production.

Specifications	
Model	MMX-200-05DX1
Rated processing pressure	200MPa
Max. processed volume (average)	830ml/min
Motor	11kw, 3P, 200V
Max. input particle size	Max 50μm (less than 10um is recommended)
External dimensions W×L×H	600×1600×1195mm
Weight	500kg



BONE CUTTER (Frozen Flaker)

These cutters are designed to crush frozen block materials, such as frozen meat and fruits and cheese, into small chips. There is no need to thaw the material, keeping it fresh, and also eliminates the need for pre-processing and the space it requires.

<Applications>

Poultry meat, fish, pork, cattle, hide, chicken bones, fruits, eggs, vegetables, butter, cheese, industrial or pharmaceutical materials

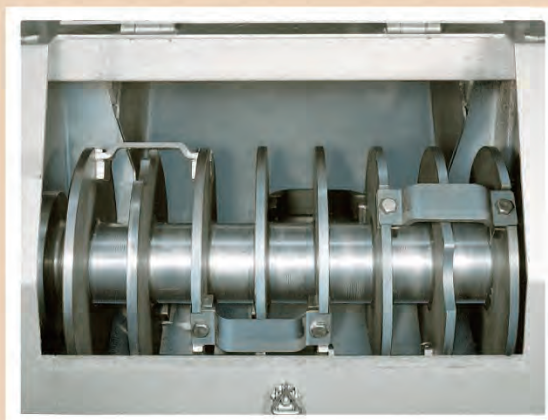

MKBFC-3 Wet Dry

● These cutters are designed to treat small lot of a material, which falls into the cutting chamber by its gravity. The simple design ensures problem-free operation, and significantly saves installation space.

Specifications

Model	MKBFC-3	MKBFC-5
Motor	2.2Kw, 3P	5.5Kw, 3P
Rotor speed (50Hz)	150r.p.m.	150r.p.m.
Standard capacity	400~500Kg/Hr	600~800Kg/Hr
Maximum input dimensions	200×400×550mm	200×500×600mm
External dimensions W×L×H	933×1510×1191mm	850×980×1300mm
Weight	270Kg	300Kg



▲MKBFC-3

MKBFC-10B Wet Dry

● This box-type model ensures safe and splash-free operation. It achieves a large capacity by using a cylinder to force-feed the material.

Specifications

Motor	5.5Kw, 3P
Rotor speed (50Hz)	150r.p.m.
Standard capacity	2000~3000Kg/Hr
Maximum input dimensions	250×500×650mm
External dimensions W×L×H	980×2300×1450mm
Weight	800Kg



CHOPPER (Chopper for frozen meat and bones:Mincer)

Masuko MK choppers can chop cattle bones, hide, and pig bones - materials traditionally considered the most difficult to chop - with just one process. The chopper consists of a special feed screw for the processed material, and a polishing-free plate, knife and spring mechanism. This design minimizes, so called, kneading disadvantage and generation of heat to ensure quality products from almost any material.

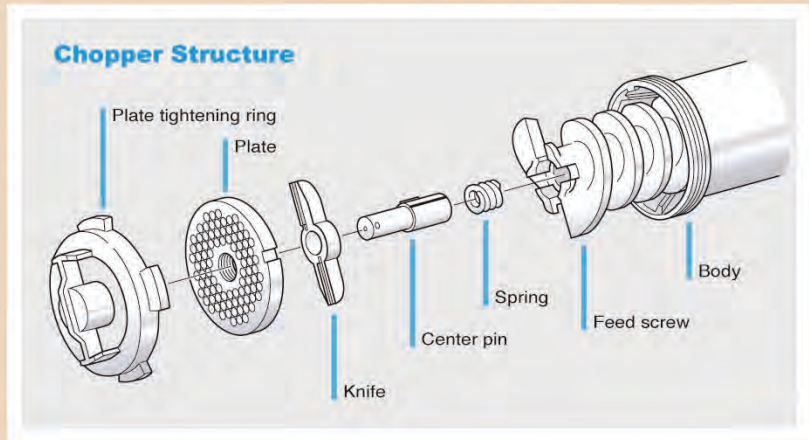

Compact Chopper **MKBC-42** Wet

● These compact machines for small-lot production are specially designed for easy disassembly and cleaning. They are available for processing chicken bones and cartilage, as well as raw and frozen meat. The MKBC-42 model incorporates a force feeding screw, which reduces labor costs by reducing the operator's work load.

Specifications			
Model	MKBC-22	MKBC-32	MKBC-42
Motor	1.5Kw, 3P	2.2Kw, 3P	7.5&11Kw, 3P
Standard capacity	20~100Kg/Hr	50~200Kg/Hr	100~1000Kg/Hr
External dimensions W×L×H	610×325×490mm	700×350×600mm	900×900×1100mm
Weight	45Kg	90Kg	280Kg



※ Compact chopper is not equipped with spring as shown above.
Center pin is screw-on type.

Heavy Duty Chopper **MKBC42MG** Wet

● Since the meat feeder (meat feed screw) and mixer for stirring the material in the vessel have been integrally incorporated, it is a space-saving and labor saving for maintenance management. You can secure a large processing capacity by meat feed screw. By controlling the rotational speed, excessive feeding of raw materials can be prevented. As the result, it is possible to prevent the overload operation, you can protect the knife and hole plate from damage or abnormal wear.

Specifications		
Model	MKBC32MG	MKBC42MG
Motor	16.2Kw	22.7Kw
Standard capacity	1~1.5Ton/Hr	1~2.5Ton/Hr
Agitation tank capacity	Full capacity 200 liters	Full capacity 450 liters
External dimensions W×L×H	800×1947×1438mm	1000×2475×1717mm
Weight	1090Kg	1800Kg



▲MKBC32MG

MIXER (High Viscosity Mixer)

Masuko MK mixers enjoy a long-held reputation for durability, and ease of operation and washing, as well as for excellent efficiency without damaging the material.

Vacuum mixers and heated kneaders are also offered on request. Agitating blades are available in either paddle or ribbon versions, according to the material to be processed.

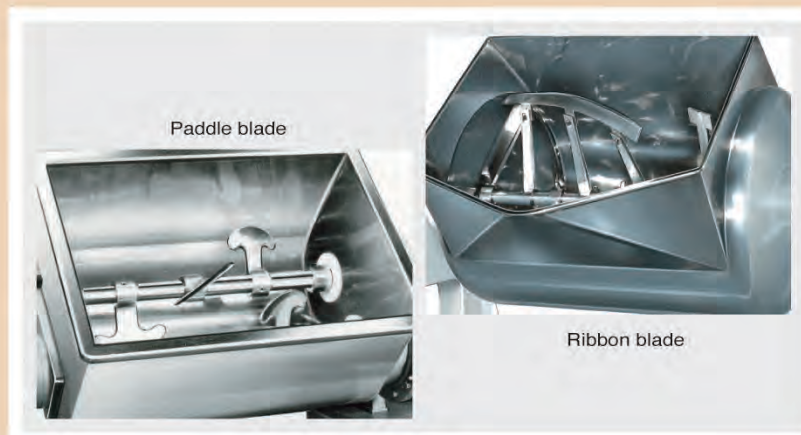

MK-4

● These are the most popular mixers with excellent levels of durability, maneuverability and serviceability which are used in various industries. Updated versions have also been well appreciated, incorporating a load cell that automatically weighs input materials and additives.

Specifications

Model	MK-06	MK-08	MK-1	MK-2	MK-3	MK-4
Vessel capacity	100ℓ	140ℓ	200ℓ	400ℓ	500ℓ	650ℓ
Net agitating capacity	60Kg	80Kg	120Kg	240Kg	300Kg	400Kg
Motor	0.75Kw, 3P	1.5Kw, 3P	3.7Kw, 3P	5.5Kw, 3P	7.5Kw, 3P	7.5Kw, 3P
Tilting method	Manual	Automatic	Automatic	Automatic	Automatic	Automatic
External dimensions W	1350mm	1450mm	2000mm	2400mm	2400mm	2570mm
	L 450	450	600	600	800	1000
	H 770	770	1080	1400	1400	1500
Weight	150Kg	300Kg	800Kg	1000Kg	1300Kg	1500Kg

※ Large-scale mixers with capacities of 500 to 2000Kg are available on request.

※ Net agitating capacity is based on specific gravity 1.



▲MK-4
With Load-Cell

MK-3R

● The MK-3R mixer integrates agitation tank, extruding screw and meat pump to allow continuous operations of agitation and transfer without tilting the vessel.

Specifications

Model	MK-3R	MK-5R	MK-6R
Vessel capacity	500ℓ	850ℓ	1000ℓ
Net agitating capacity	300Kg	500Kg	600Kg
Motor	11Kw, 3P	11Kw, 3P	15Kw, 3P
External dimensions W×L×H(mm)	2750×1800×2500	2750×1000×1500	2650×1300×1900
Weight	2000Kg	2400Kg	2900Kg

※ Net agitating capacity is based on specific gravity 1.

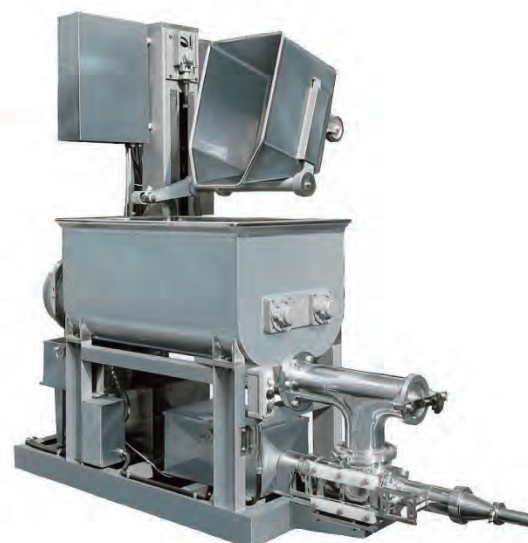

▲MK-3R
With Lift-Boy

PERIPHERAL EQUIPMENT

Pulverizer **MKP-10** Dry

● This pulverizer is designed to provide low-speed crushing at peripheral speeds of 30m/sec to make coarse particle size (100~300 μm) products. The characteristics of this pulverizer are low-speed, less numbers of hammers, and big clearance in the pulverizing room. This pulverizer also provides stable particle size products and high working capacity.

Specifications

Model	MKP-3	MKP-10	MKP-20
Motor	2.2+0.4Kw	7.5+0.4Kw	11+0.4Kw
No. of hammers	6 pieces (1 line)	12 pieces (2 lines)	24 pieces (4 lines)
Standard capacity	50~200Kg/Hr	200~800Kg/Hr	600~1500Kg/Hr
External dimensions W×L×H	1000×700×1550mm	1200×1000×1830mm	1850×1550×2100mm
Weight	300Kg	800Kg	800Kg



▲MKP-10

Bone Crusher **MKBP-200** Wet Dry

● This crusher is designed to crush garbage and animal bones, and achieves a high capacity of one to two tons per hour. Variable speed drive is used to ensure efficient operation according to the size and the properties of the material being processed. Automatic reversal is provided in case there is an overload.

Specifications

Motor	7.5Kw, 3P
Standard capacity	1~2ton/hr.
Roll diameter	φ300mm
No. of cutters	5pcs×2 lines
Hopper bore dia.	400×415mm
External dimensions W×L×H	1000×2260×2000mm
Weight	1700Kg



Food Cutter **MKFS-302** Wet Dry

● Provided with a big capacity, this machine chops instantly such vegetables into pieces as cabbage, onion and etc. As a whole head of cabbage can be fed at a time in spite of its compact structure, this machine enables efficient operation. By its special cutter made of stainless steel, it makes up smooth cut surface of vegetables.

Specifications

Model	MKFS-104	MKFS-302
Motor	1.5Kw, 3P	2.2Kw, 3P
Standard capacity	500~700Kg/hr	1000~1500Kg/hr
External dimensions W×L×H	730×400×1150mm	930×500×1200mm
Weight	80Kg	150Kg

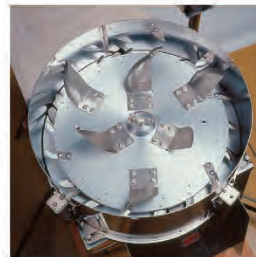

▲MKFS-302

Sanitary-type continuous powder collector Dry

● Sanitary bag filter used with fine powder making machine like Ceren Miller or Atomizer. It can collect almost 100% of the product. Quite sanitary with its product contact part made of stainless steel and finished by #400 polish. Being not tall thanks to a built-in table feeder, it can be installed in a rather low area.

Specifications	
Motor	1.5Kw, 3-phase
Processing air volume	10m ³ /min
Filtering area	9.9m ²
Body material	SUS304
External dimensions W×L×H	1109×1400×3211mm
Weight	500Kg

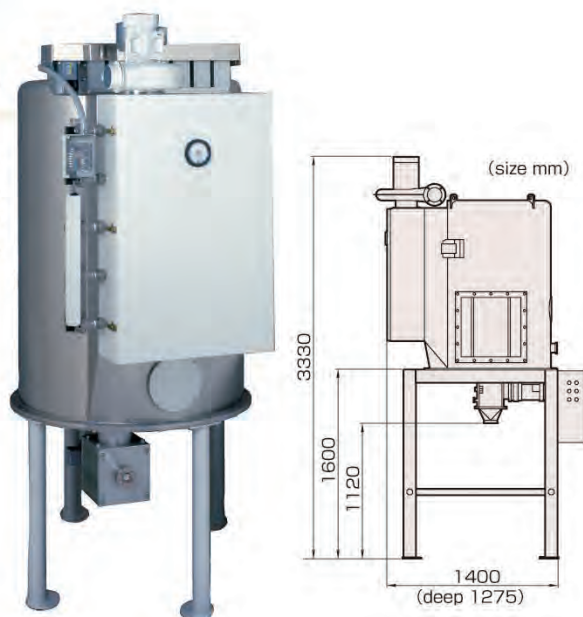

Mohno-pump **NBLS-40MR** Wet

● With quantitative and self-priming features, the NBLS-40MR pump ensures vibration-free transfer of food, chemical and industrial materials, even those with high density and viscosity.

Specifications			
Model	NBLS-20MR	NBLS-30MR	NBLS-40MR
Motor	0.4Kw, 3P	0.75Kw, 3P	1.5Kw, 3P
Standard capacity	0.7~16.5ℓ/min	2.6~61ℓ/min	4.7~108ℓ/min
External dimensions W×L×H	400×830×600mm	600×1200×700mm	800×1200×800mm
Weight	80Kg	110Kg	150Kg



Quantitative Charger Wet

● Gravimetric quantitative Charger using a load cell, with weighing error within ±2% thanks to its head correction function. Its measurement is adjustable between 1-30Kg.

Specifications	
Compressor	0.2Kw, 3P
Charging amount	1~30kg/charging
Filling error	±2%
Filling valve	Sanitary air pressure valve
External dimensions W×L×H	1500×1400×1330mm
Weight	130Kg



Vertical Conveyor **MKVC-1700** Wet Dry

● The Vertical Conveyor requires only 30% of the space of a conventional inclined screw conveyor. Both horizontal and vertical screws can be removed or installed by a single action for thorough cleaning of components. This model can convey powders, particles and viscous materials.

Specifications	
Motor	1.5Kw, 3P
Carrying capacity	3.2Ton/hr.(Max.)
External dimensions W×L×H	1200×600×2000mm
Weight	120Kg





Masuko contributes to countries around the world as a new leader
in developing resources that have not ever been utilized.



Making a challenge in the field of microsized materials.

MASUKO SANGYO CO., LTD.

12-24, Honcho-1-chome, Kawaguchi-shi, Saitama-ken 332-0012, JAPAN.
Tel.+81-48-222-4343 Fax.+81-48-223-9790
E-mail:e-information@masuko.com

You can access
the Masuko home page on the Internet
<http://www.masuko.com>

● Specifications are subject to change without prior notice.